

LR-4WN and R3C

4 zones RF controller and receiver for single colour LED strip

Product Description

The LR-WN remote enables control of upto 4 zone of single colour LED strip. Featuring a scroll wheel which enables the user to adjust the brightness of the connected LED strip. The remote also allows one to save preferred brightness levels.

Features

- 4 zone single colour controller
- Scroll wheel for easy brightness adjustment.
- Smooth dimming capacity.
- 2.4GHz wireless technology, enabling remote distance of up to 30m.
- Operates with an LED indicator light for ease of use.
- PWM dimming enables flicker-less dimming

Technical Specification

Controller	
Order Code	LR-4WN
Type	RF Remote
Input Voltage	3VDC
Operation Frequency	2.4GHz
Dimension	58.5x107x9mm (WxLxH)
Power	battery CR2032

Receiver	
Order Code	R3C
Type	RF receiver
Input Voltage	12-36VDC
Current	3x4A
Output	144-288W
Note	Constant voltage
Dimension	33x97x18mm (WxLxH)

Product Image



Recommendation

RF technology allows for greater flexibility when it comes to controlling simple or complex lighting installations without the need of additional cabling.

There are some limitations where installations have the receivers enclosed in electrical boxes or hidden away in a ceiling, reducing the RF signal strength and therefore the communication range.

In order to overcome these RF Signal restrictions we suggest the following when synchronising our RF controllers and receivers:

- Keep the distance within 10 meters from the controller to the receiver. The remote can operate up to 30 meters if signal is uninterrupted by obstacles.
- When expanding your lighting, always try and use a signal repeater (PR-RGB), where possible.
- If your installation requires several RF receivers, ensure the "master" receiver is positioned in the middle.

CONTROLLER AND RECEIVER

LR-4WN and R3C

4 zones RF controller and receiver for single colour LED strip

Controller layout

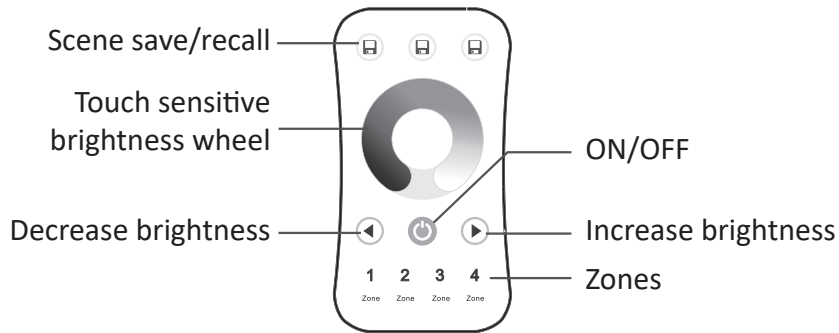

Receiver wiring diagram

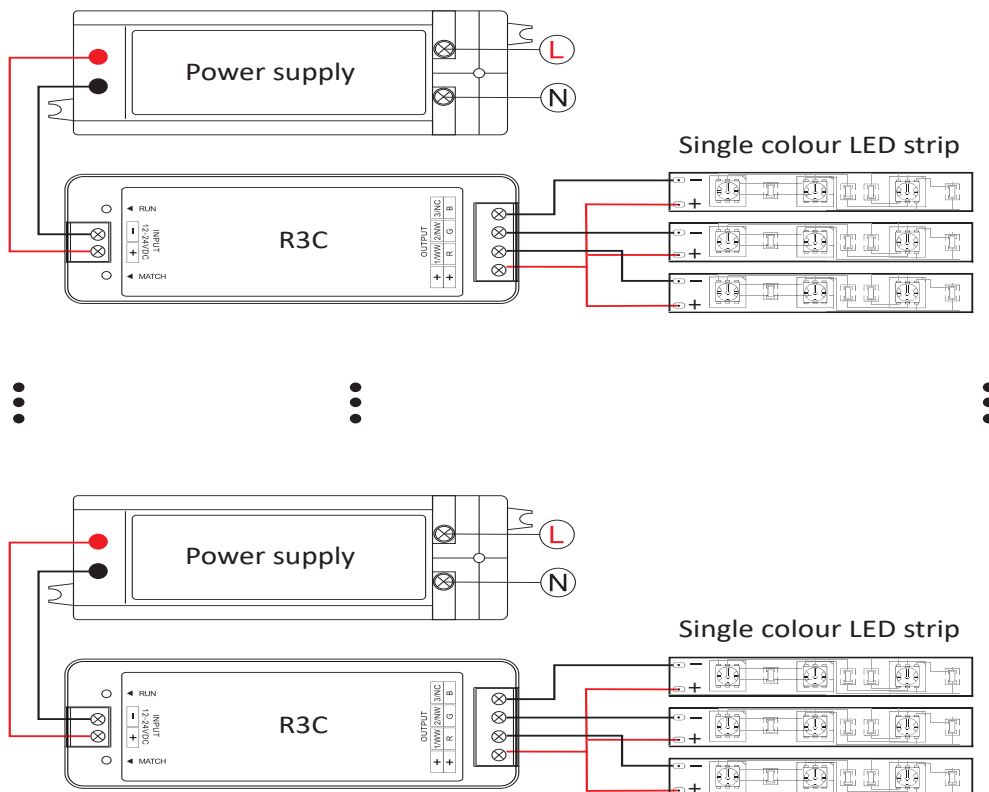

CONTROLLER AND RECEIVER

LR-4WN and R3C 4 zones RF controller and receiver for single colour LED strip

Synchronising the remote to receiver

1) Ensure the receiver has power. Press the match button on the receiver. Indicator will start flashing.

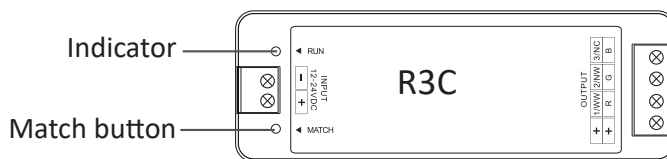

2) Choose the required zone on the remote to allocate the receiver within 5 seconds after pressing the match button. The indicator will stop flashing, and the controller will be synchronised.

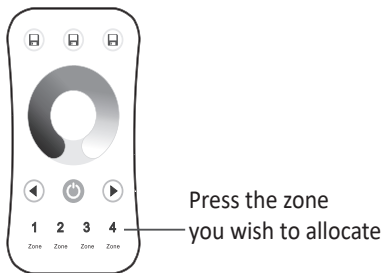

3) Repeat the process to allocate zones for all receivers.

4) To restore to factory default settings and delete the allocated controller, press and hold the match button longer than 5 seconds.

Troubleshoot

Problem	Cause	Corrective
No light	<ul style="list-style-type: none"> No power. Wrong connection or unsecure connection. 	<ul style="list-style-type: none"> Check the power. Check the connection.
Wrong Colour	<ul style="list-style-type: none"> Wrong connection of LED strip wires. 	<ul style="list-style-type: none"> Re trace and reconnect LED strip wires.
Uneven intensity between front and rear of the strip, with voltage drop	<ul style="list-style-type: none"> Output cable is too long. Cable diameter is too small. Overload beyond driver capability. Overload beyond receiver capability. 	<ul style="list-style-type: none"> Reduce cable or loop supply. Change to a thicker cable. Replace with a suitable higher power driver. Add a power repeater.
No response from the remote	<ul style="list-style-type: none"> The battery has no power. Beyond controllable distance. The controller isn't synchronised with the remote. 	<ul style="list-style-type: none"> Replace battery. Reduce remote to receiver distance. Re-sync the remote.

CONTROLLER AND RECEIVER



Brighter for longer

LR-4WN and R3C

4 zones RF controller and receiver for single colour LED strip

Controlling your LED strip

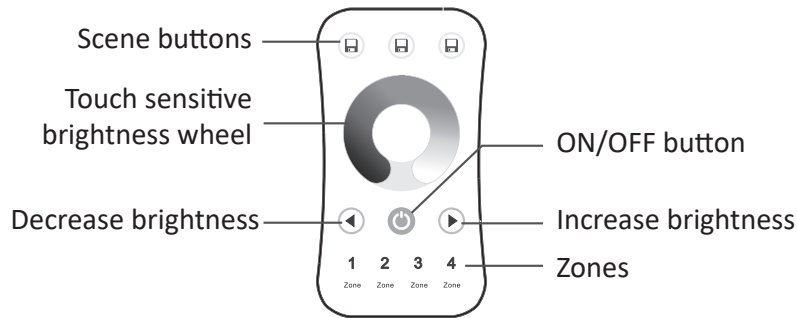

- Choose the zone(s) you wish to control.
- To change brightness, use the touch wheel, or press the buttons for increasing / decreasing brightness.

- To save your favourite setup, press and hold scene buttons.
- To recall saved setup, press scene button.
- You can save up to 3 scenes.

Safety

- Products must be installed and serviced by qualified electrician.
- Please ensure the receiver is mounted in a water proof enclosure if installed in an outdoor environment, avoiding metallic enclosures.
- Always ensure products are mounted in areas with adequate ventilation to avoid overheating.
- Please ensure outputs of any power suppliers used in conjunction with this product comply with its working voltage.
- Never install product whilst connected to power and double check connections before switching on to avoid short circuits.

Warranty

Should this product fail during the 3 year warranty period it will be replaced free of charge, subject to the correct installation of the original product in accordance with applicable and appropriate electrical codes and instructions provided by Teucer, as well as subsequent return of the faulty unit. Teucer does not accept responsibility for any installation costs associated with the replacement of this product and Teucer reserves the right to alter specifications without prior notice. Teucer can offer 5 year warranty upon request. For further information, please see our Terms and Conditions. www.teucerled.co.uk/terms-and-conditions/

Teucer (UK) Ltd
Head office

Bedford House, Fulham Green, Fulham High Street,
London, SW6 3JW, UK
Tel: +44 (0)20 7350 4429
Fax: +44(0)20 7228 4647
www.teucerled.co.uk
sales@teucer.eu

Logistics Centre

Trident Court,
1 Oakcroft Road,
Chessington,
Surrey, KT9 1BD, London, UK
Tel: +44(0)20 7350 4429, extension: 401
warehouse@teucer.eu

