

WP-4RGBWN and R3C 4 zones RF controller with R3C receiver for RGB LED strip

Product Description

The WP-4RGBW wall panel enables control of 1 to 4 zones of RGB LED strip. Featuring a simple to use back lit touch control slider for easy colour adjustment .

Features

- Enables control via DMX (DMX decoder required for DMX) or wirelessly via RF
- Supports single zone independent control or multiple zone synchronous control.
- Ultra-sensitive backlit high strength glass touch panel.
- Smooth and accurate colour adjustment via a touch colour slider.
- Independent brightness adjustment of each RGB channel to achieve a vast pallet of colours.
- Built in 30 optional change modes with adjustable speed and brightness.

Technical Specification

Controller	
Order Code	WP-4RGBWN
Type	RF and DMX wall panel
Input Voltage	AC85-265V
Operation Frequency	2.4GHz
Dimension	86x86x36.5mm (WxLxH)

Receiver	
Order Code	R3C
Type	RF receiver
Input Voltage	12-24VDC
Current	3x4A
Output	144-288)W
Note	Constant voltage
Dimension	33x97x18mm (WxLxH)

Product Image



Recommendation

RF technology allows for greater flexibility when it comes to controlling simple or complex lighting installations without the need of additional cabling.

There are some limitations where installations have the receivers enclosed in electrical boxes or hidden away in a ceiling , reducing the RF signal strength and therefore the communication range.

In order to overcome these RF Signal restrictions we suggest the following when synchronising our RF controllers and receivers:

- Keep the distance within 10 meters from the controller to the receiver. The remote can operate up to 30 meters if signal is uninterrupted by obstacles.
- When expanding your lighting, always try and use a signal repeater (PR-RGB), where possible.
- If your installation requires several RF receivers, ensure the “master” receiver is positioned in the middle.

CONTROLLER AND RECEIVER



Brighter for longer

WP-4RGBWN and R3C

4 zones RF controller with R3C receiver for RGB LED strip

Controller layout

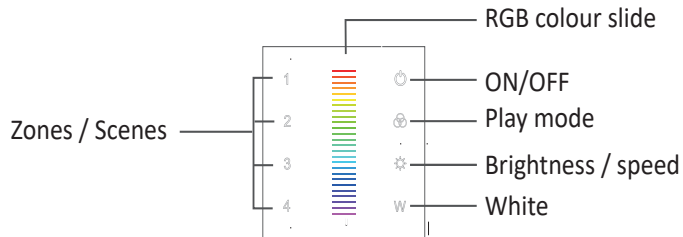

Receiver wiring diagram

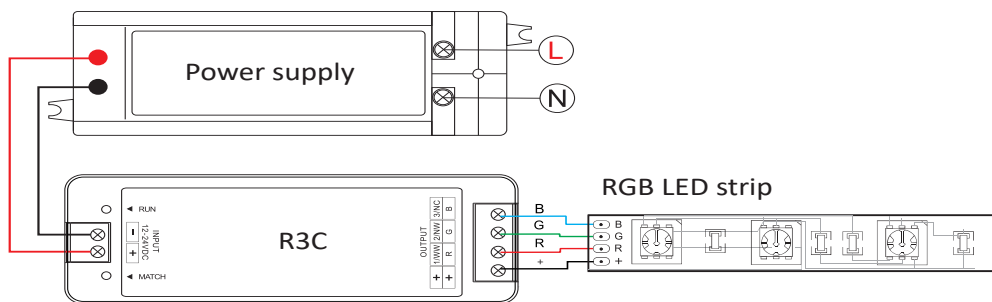

Dip switch settings

Caution: before power ON, you must confirm the dip switch selection.

RGB Dipswitch setting for 4 Scenes

Dipswitch no 1: DOWN (OFF)

Dipswitch no 2: DOWN (OFF)

Dipswitch no 3: RF - UP (ON)

RGB Dipswitch setting for 4 zones

Dipswitch no 1: DOWN (OFF)

Dipswitch no 2: UP (ON)

Dipswitch no 3: RF - UP (ON)

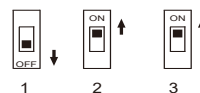
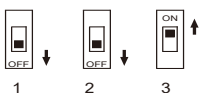

WP-4RGBWN and R3C

4 zones RF controller with R3C receiver for RGB LED strip

Synchronising the remote to receiver

1) Ensure the receiver has power. Press the match button on the receiver. Indicator will start flashing.

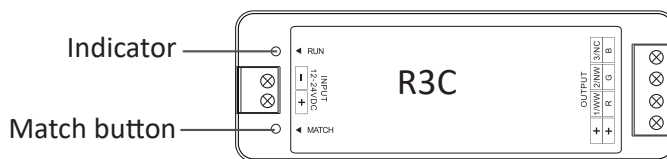

2) Choose the zone you wish to allocate on the panel within 5 seconds after pressing the match button. The indicator will stop flashing, and the controller will be synchronised.

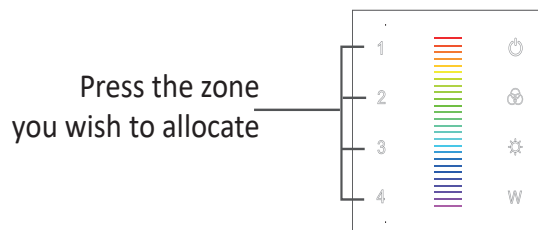

3) Repeat the process to allocate zones for all receivers.

4) To restore to factory default settings and delete the allocated controller, press and hold the match button longer than 5 seconds.

Troubleshoot

Problem	Cause	Corrective
No light	<ul style="list-style-type: none"> No power. Wrong connection or unsecure connection. 	<ul style="list-style-type: none"> Check the power. Check the connection.
Wrong Colour	<ul style="list-style-type: none"> Wrong connection of RGB/W wires. 	<ul style="list-style-type: none"> Retrace and reconnect RGB/W wires.
Uneven intensity between front and rear of the strip, with voltage drop	<ul style="list-style-type: none"> Output cable is too long. Cable diameter is too small. Overload beyond driver capability. Overload beyond receiver capability. 	<ul style="list-style-type: none"> Reduce cable or loop supply. Change to a thicker cable. Replace with a suitable higher power driver. Add a power repeater.
No response from the remote	<ul style="list-style-type: none"> The wall panel has no power. Beyond controllable distance. The controller isn't synchronised with the remote. 	<ul style="list-style-type: none"> Check the incoming supply to the wall panel. Reduce remote to receiver distance. Re-sync the remote.

CONTROLLER AND RECEIVER



Brighter for longer

WP-4RGBWN and R3C

4 zones RF controller with R3C receiver for RGB LED strip

Controlling your LED strip

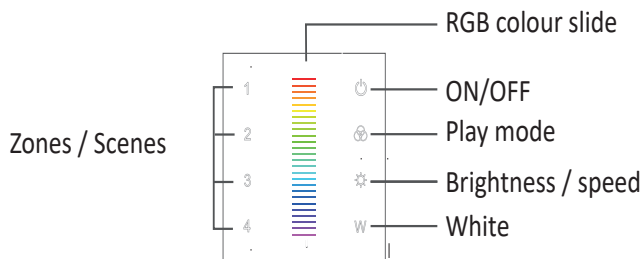

- To adjust the colour, touch the RGB colour slider.
- To change the brightness, press the brightness button.
- On/Off: For single zone: Turn ON/OFF strips.
- For 4 Zone: Short press turn ON/OFF current zone light, long press 2s turn OFF all zones strips.
- Mode: Short press to run next mode, long press 2s runs mode-cycle.
- W: Short press to turn ON/OFF W channel,
- Long press 1-5s for continuous 256 levels adjustment of the white channel brightness.
- Zone: Choose the zone you wish to control.
- Zone / Scene: When used as 4 scene: Short press to run the scene, long press 2s to save.

- There are 30 dynamic modes, press the play mode button to browse through modes. To choose the mode, press and hold play mode for 2 seconds.
- There are 10 speeds for the play modes. Press the speed button to browse through the speed levels.
- Press and hold the speed button to go to the highest speed level.
- To save your favourite setup, press and hold scene buttons.
- To recall saved setup, press scene button.
- You can save up to 4 scenes.

Safety

- Products must be installed and serviced by qualified electrician.
- Please ensure the receiver is mounted in a water proof enclosure if installed in an outdoor environment, avoiding metallic enclosures.
- Always ensure products are mounted in areas with adequate ventilation to avoid overheating.
- Please ensure outputs of any power suppliers used in conjunction with this product comply with its working voltage.
- Never install product whilst connected to power and double check connections before switching on to avoid short circuits.

Warranty

Should this product fail during the 3 year warranty period it will be replaced free of charge, subject to the correct installation of the original product in accordance with applicable and appropriate electrical codes and instructions provided by Teucer, as well as subsequent return of the faulty unit. Teucer does not accept responsibility for any installation costs associated with the replacement of this product and Teucer reserves the right to alter specifications without prior notice. Teucer can offer 5 year warranty upon request. For further information, please see our Terms and Conditions. www.teucerled.co.uk/terms-and-conditions/

Teucer (UK) Ltd
Head office

Bedford House, Fulham Green, Fulham High Street,
London, SW6 3JW, UK
Tel: +44 (0)20 7350 4429
Fax: +44(0)20 7228 4647
www.teucerled.co.uk
sales@teucer.eu

Logistics Centre

Trident Court,
1 Oakcroft Road,
Chessington,
Surrey, KT9 1BD, London, UK
Tel: +44(0)20 7350 4429, extension: 401
warehouse@teucer.eu

